

Seminar Registration 2024

Current Schedule of Virtual Workshop Offerings

This year we combine live, in-person elements with digital, online components. All workshops will take place over video conference and you can interact live with the trainer and attendees, as if you were physically in the classroom.

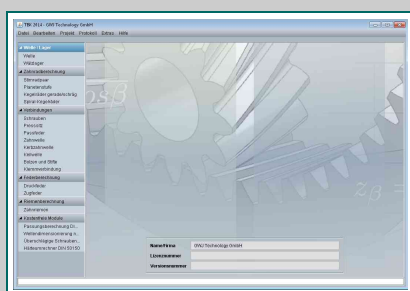
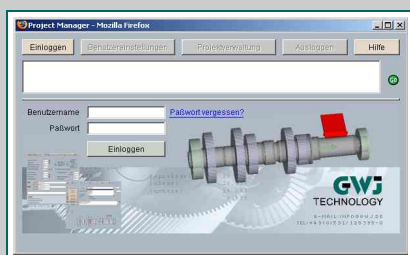
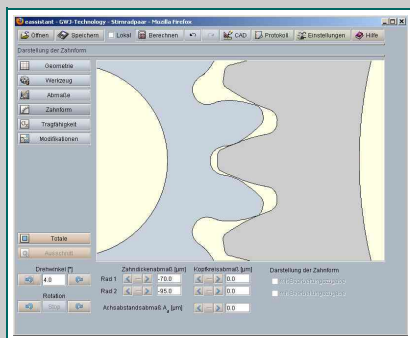
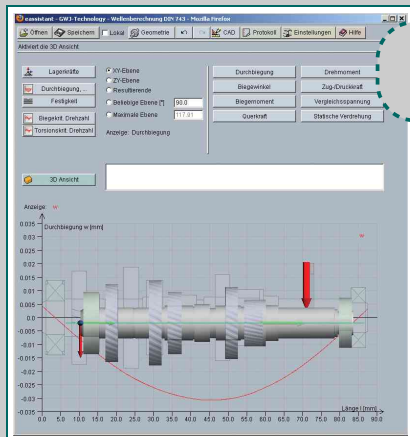

Basics, Design & Optimization of Cylindrical Gears

Date and time on request

Duration: 3 x 2 hours | 420 EURO per person

Bevel Gears

Date and time on request

Duration: 3 x 2 hours | 660 EURO per person

NEW

Shaft-Hub Connections

Date and time on request

Duration: 2 x 2 hours | 340 EURO per person

NEW

Shafts and Bearings

Date and time on request

Duration: 2 x 2 hours | 340 EURO per person

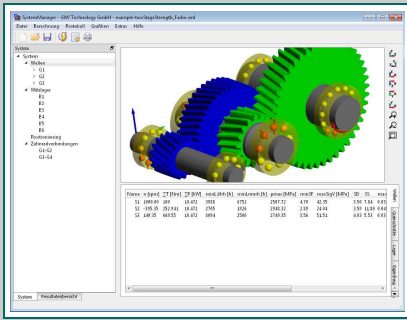

SystemManager

Date and time on request

Duration: 3 x 2.5 hours | 730 EURO per person

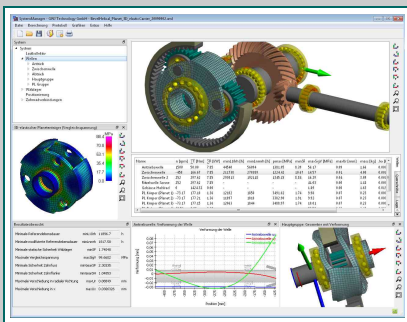

Bolted Joints

Date and time on request

Duration: 2 x 2 hours | 660 EURO per person

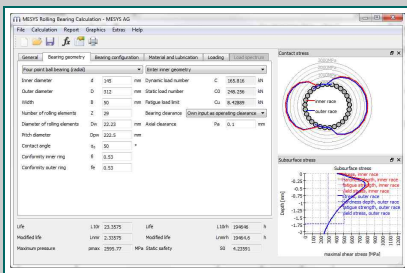

General Information

Please fill out the form below to register for the workshop you want attend and send it back by fax or email. Don't forget your email address. You will receive a confirmation by email. Please consider the registration as binding.

These prices are indicated in EURO. All prices are strictly net and exclusive of value added tax. The workshop price includes all the study material and every attendee will receive a certificate.

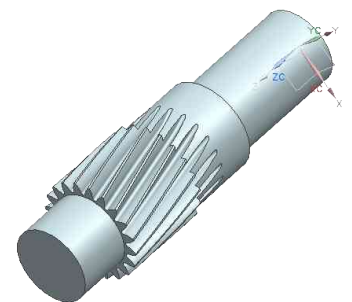
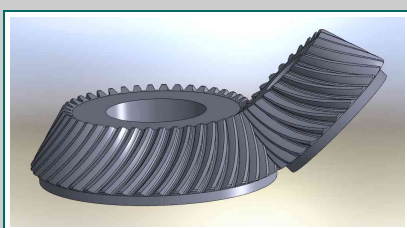
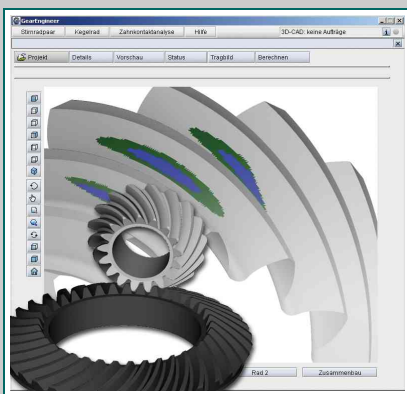

Binding Registration (Please fill in completely)

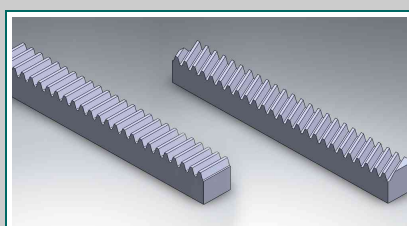
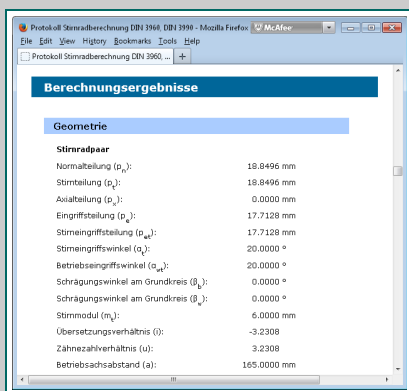
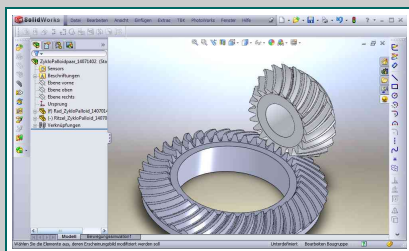
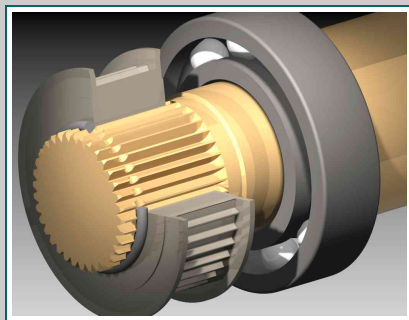
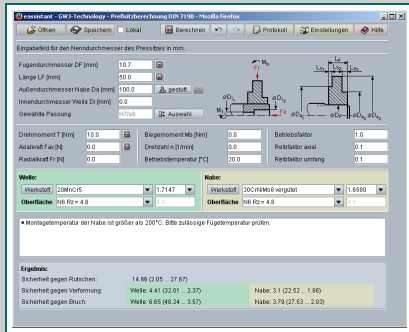

Company: _____

Department: _____

Street: _____

Postcode/City: _____

Telephone: _____

Fax: _____

Date: _____

Signature: _____

Attendee: _____

Email: _____

Attendee: _____

Email: _____

Attendee: _____

Email: _____

Attendee: _____

Email: _____

Attendee: _____

Email: _____

Attendee: _____

Email: _____

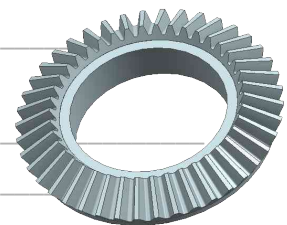

**Fill in and fax your order to +49 (0) 531 129 399-29
or send by email to info@gwj.de.**